

RPLIDAR S2

Low Cost 360 Degree Laser Range Scanner

Development Kit User Manual

Model: S2

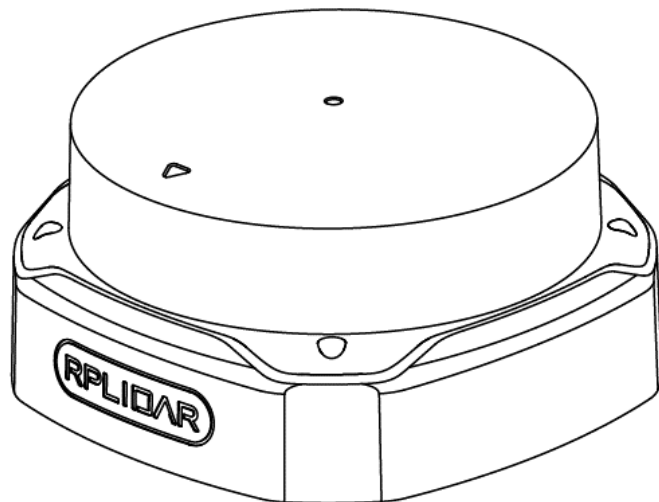

CONTENTS	1
OVERVIEW	3
ITEMS IN THE DEVELOPMENT KIT	3
RPLIDAR S2	4
USB ADAPTER.....	4
CONNECTION AND USAGE	5
CONNECTION	5
INSTALL DRIVER FOR THE USB ADAPTER.....	5
RUN DEMO APPLICATION	7
TROUBLESHOOTING.....	10
MOTOR SPEED ADJUSTMENT.....	10
SDK INTRODUCTION AND USAGE	12
RPLIDAR S2 PIN DEFINITION AND SPECIFICATION.....	12
PIN DEFINITION FOR THE USB ADAPTER.....	13
USB-DC POWER CORD INSTRUCTION	13
CONFIGURE RPLIDAR S2 SCAN FREQUENCY	13
SDK USAGE.....	13
OPERATION RECOMMENDATION	14
PRE-HEATING FOR BEST PERFORMANCE	14
AMBIENT TEMPERATURE.....	14
AMBIENT LIGHT	14
REVISION HISTORY	15
APPENDIX	16
IMAGE AND TABLE INDEX	16

RPLIDAR S2 development kit includes the matched tools used for evaluating RPLIDAR's performance and initial development. After connecting the RPLIDAR S2 with PC via USB cable and connecting the power adapter to the USB cable, users can observe the cloud map of the environment scanning point collected by the RPLIDAR in RoboStudio and start development based on the SDK.

Items in the Development Kit

RPLIDAR Development Kit contains:

- RPLIDAR (PWM motor driver embedded)
- USB Adapter
- Micro-USB cable
- Power cable



Figure 1-1 Items in the RPLIDAR Development Kit

RPLIDAR S2



Figure 1-2 The RPLIDAR S2

The RPLIDAR S2 development kit contains standard RPLIDAR S2 unit. The RPLIDAR is embedded with logic IO drivable motor controller which can be used to configure the scan frequency by tuning motor speed. Developers can also choose to turn off the motor for power saving purpose.

RPLIDAR usage and interface definition will be introduced in the coming sections.

USB Adapter

The USB adapter supports a communication rate of 1M baud.



Figure 1-3 RPLIDAR Adapter

Connection

RPLIDAR S2 can be easily connected to PC according to the following steps.

- 1) Connect RPLIDAR S2 with the USB adapter.



Figure 2-1 Connect RPLIDAR S2 and USB Adapter

- 2) Connect the USB adapter to your PC via the Micro-USB cable. If the PC is on, after connecting the USB cable to your PC and connecting the power adapter to the USB cable, the indicator light of the USB will light up but the RPLIDAR will not start scanning.



Figure 2-2 Connect the USB Adapter to PC via Micro-USB Cable

Install Driver for the USB Adapter

The USB adapter converts UART to USB by using CP2102 chip. You need to install the device driver for the chip. The driver can be found in the provided SDK package or downloaded from Silicon Labs' official website:

<http://www.silabs.com/products/mcu/Pages/USBtoUARTBridgeVCPDrivers.aspx>

Here's the installation steps in Windows: after connecting the RPLIDAR with PC, please find the driver file "CP210x VCP Windows" and choose correct operating system version accordingly: x86 for 32-bit OS and x64 for 64-bit OS.

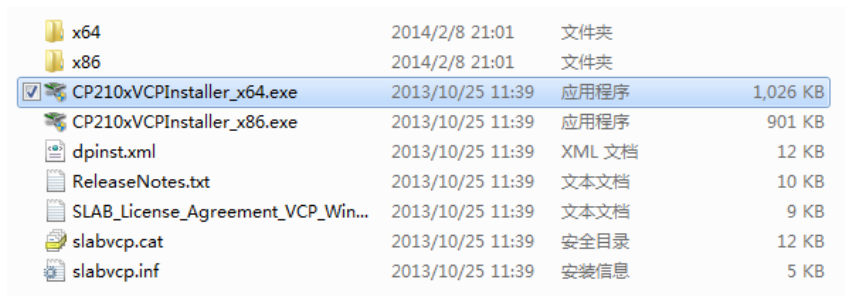

Figure 2-3 Choose USB Adapter Driver for Installation

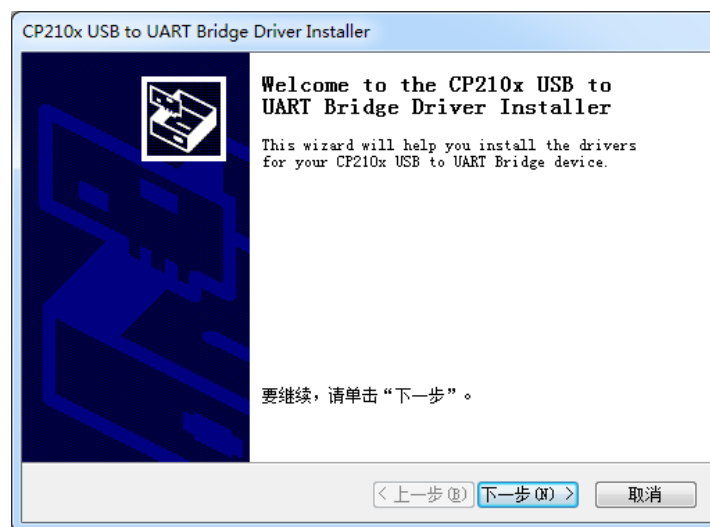

Figure 2-4 Start Page of USB Adapter Driver Installation

After Installing the driver according to the above installation steps, you will see corresponding serial port name in the [Control Panel] -> [Device and Printers]. Please refer to the below figure.

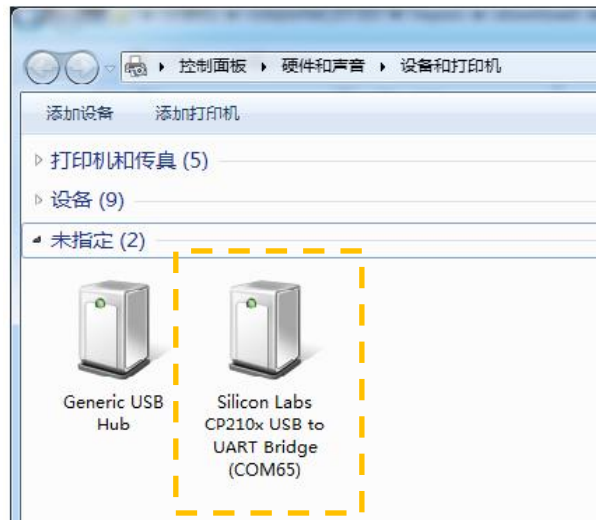

Figure 2-5 Recognized Serial Port Name Matched with the USB Adapter

Run Demo Application

SLAMTEC provides a Lidars plugin in RoboStudio for users in test and evaluation. You can view the scan result directly in the UI and save the scan result to files for further processing.

This GUI demo can only run under Windows. For Linux and MacOS users, please refer to the other simple demo provided in the SDK.

Please make sure you have connected RPLIDAR to PC by using USB adapter and installed the device driver correctly before running the demo application in RoboStudio. Launch RoboStudio and log in.

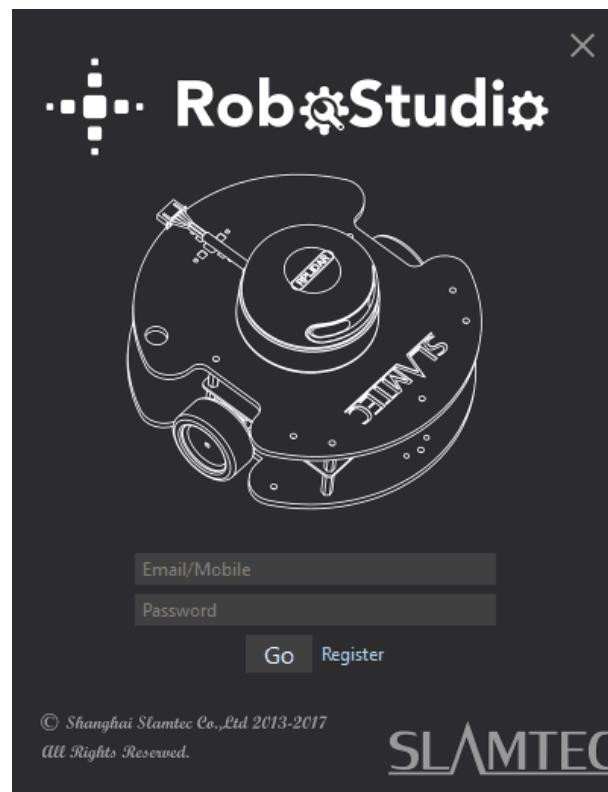

Figure 2-6 RoboStudio Login Page

If the connection is ok, you shall see the user interface is shown as below.

1. Click **File**->**Lidars** to open the lidar control panel in the left;
2. Click **Serial Ports** to extend the lidar lists and you'll find the RPLIDAR S2 previously connected to your PC;
3. Click the RPLIDAR S2 icon to extend the tool buttons below the icon: the left one is to adjust the motor speed while the right one is to open the tool bar in the major work area as shown in Figure 2-7.

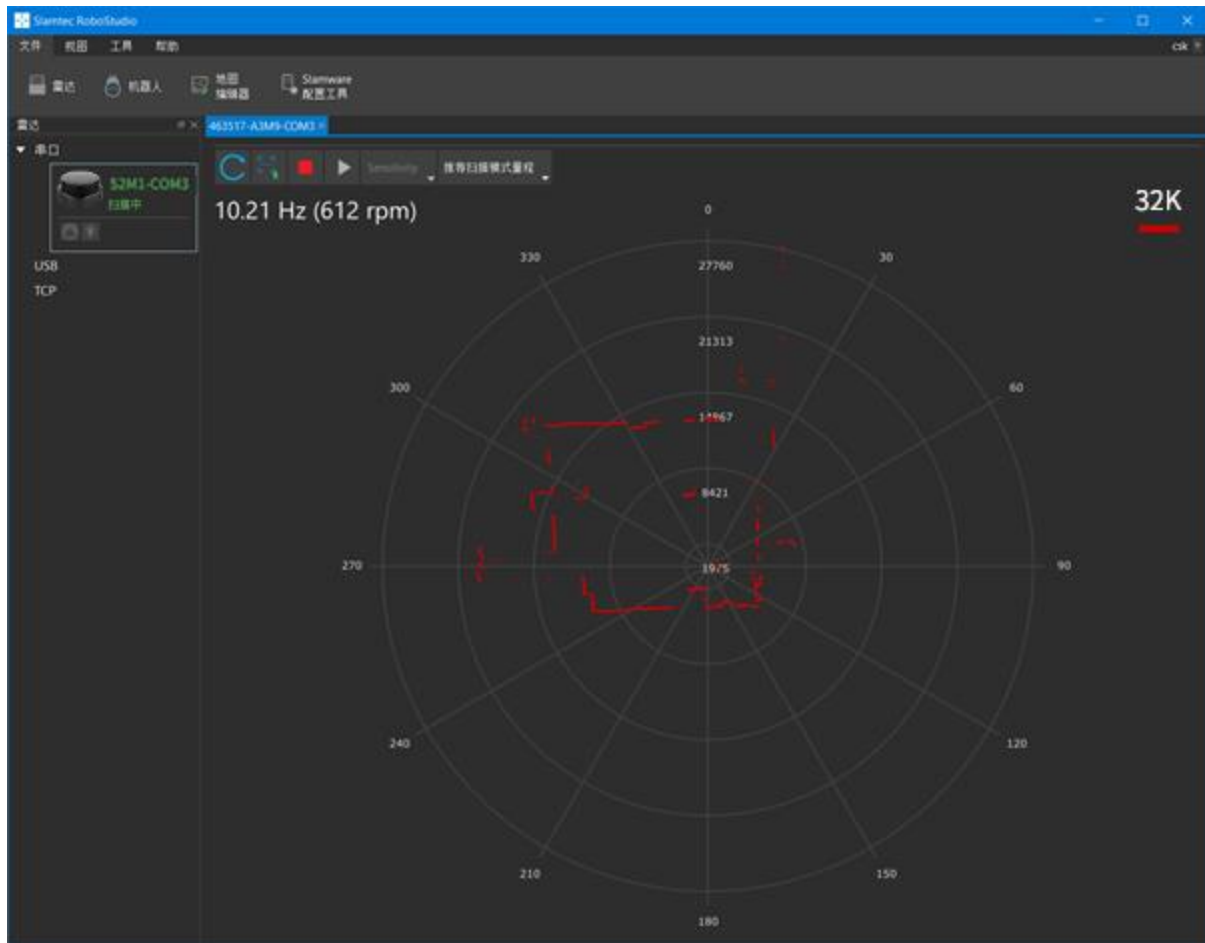

Figure 2-7 The Lidar Plugin in RoboStudio

The serial number, version and model of the RPLIDAR S2 will show next with its icon in the lidar control panel. The supported commands of RPLIDAR are showed in the tool bar. The descriptions are listed in the bellow table.







Button	Function	Description
	Restart RPLIDAR	Restart scan core to clear internal errors
	Save Scan Data	Save current scan data to the local file
	Stop Scan	Scan core enter power save mode
	Start Scan	Scan data will be displayed after scan core starting work
	Work Mode Switch	Switch among different work modes to fit in specific environments
	Adjust Motor Speed	Adjust the motor speed as required

Figure 2-8 The Supported Commands of RPLIDAR in RoboStudio

Press the Start Scan button , the scan data will be displayed as below (by default, the motor rotating speed should be about 10Hz.):

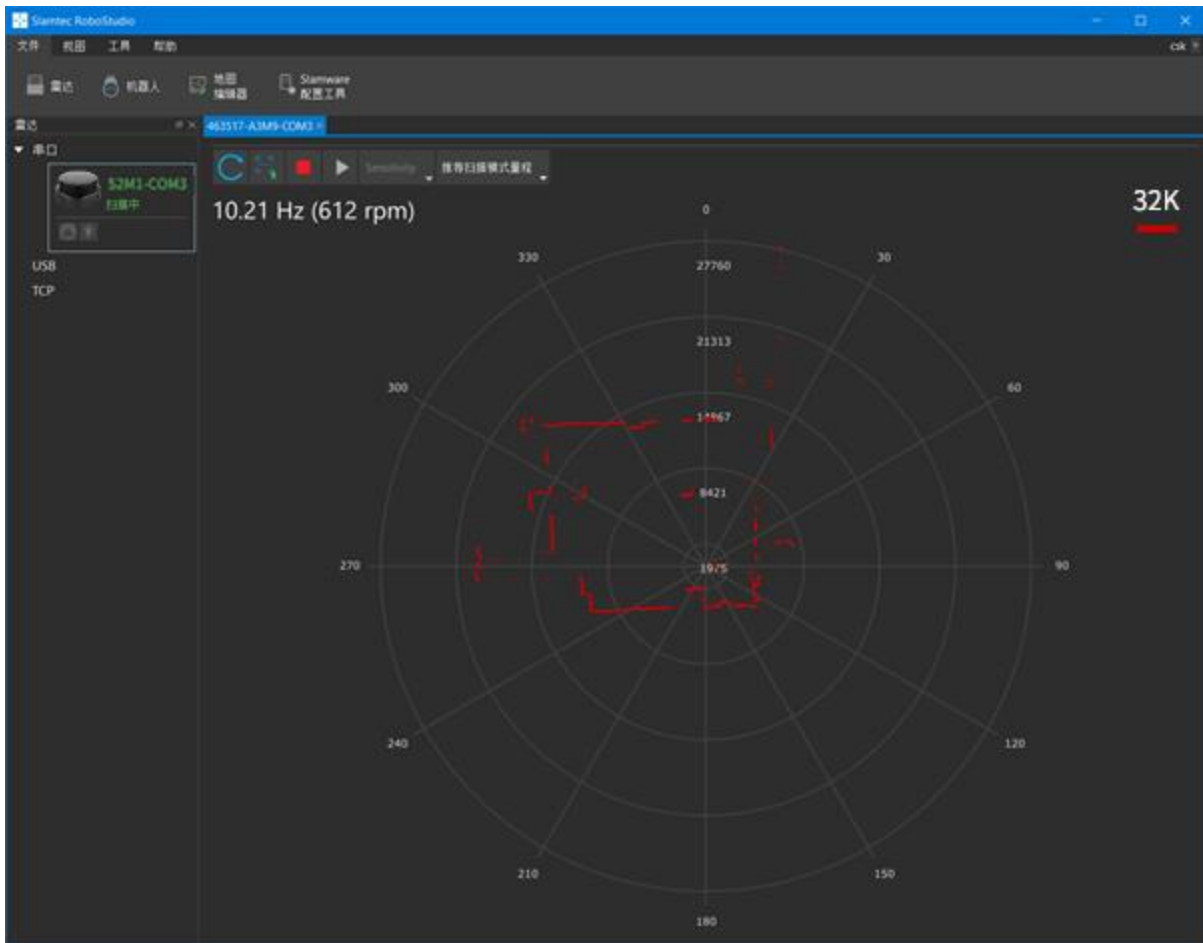



Figure 2-9 The Scan Outline by RPLIDAR in RoboStudio

Right click in the major working area to choose a range so as to zoom in or out the view.

The scan frequency is also showed in the above interface.

Troubleshooting

When the scan core or the laser power works abnormally, the scan core will enter protection mode. This state can be retrieved via SDK API. If such scenario happened, please send restart command  to reset the scan core.

Motor Speed Adjustment

During the running process, different motor rotating speed can be achieved by pressing the  button, which can fit in different working environments or meet specific requirements. There will be a speed adjustment dialog box and dash board popped up for users to enter required speed. After entering a value, the

motor will work as the settled rotating speed automatically. User can also drag the sliding handle to the required rotating speed.

The current actual rotating speed will show in the upper left corner of the major work area. For instance, the actual rotating speed in the following screenshot is 12.88Hz.

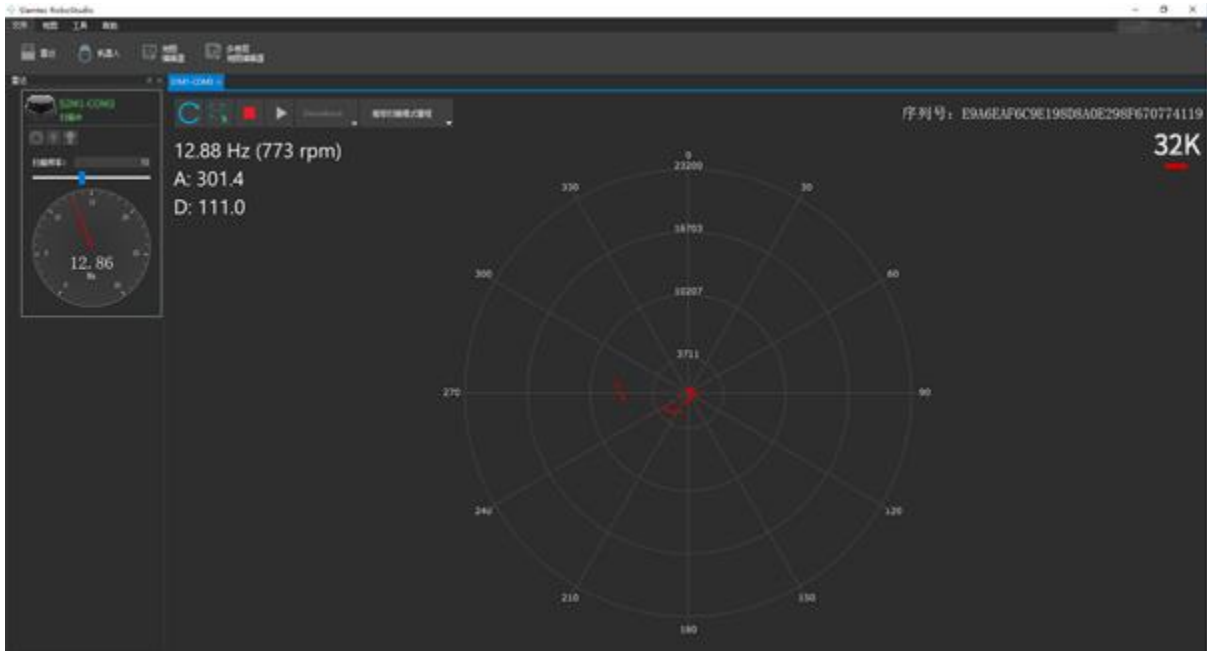

Figure 2-10 The Motor Speed Adjustment Dialogue of RPLIDAR in RoboStudio

RPLIDAR S2 Pin Definition and Specification

The RPLIDAR S2 uses separate 5V DC power for powering the range scanner core and the motor system. And the standard RPLIDAR S2 uses XH2.54-5P male socket. Detailed interface definition is shown in the following figure:

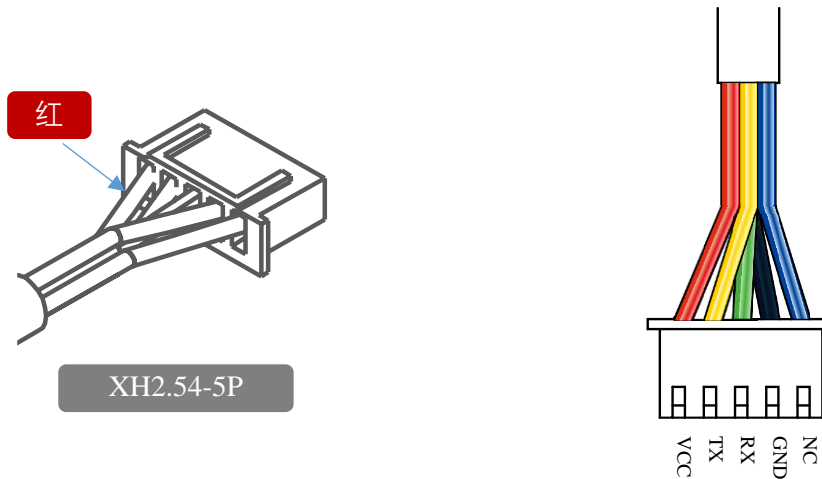

Figure 3-1 RPLIDAR S2 Pins

Color	Signal Name	Type	Description	Min	Typical	Max
Red	VCC	Power	Total Power	4.9V	5V	5.2V
Yellow	TX	Output	Serial port output of the scanner core	0V	/	3.5V
Green	RX	Input	Serial port input of the scanner core	0V	/	3.5V
Black	GND	Power	GND	0V	0V	0V
Blue	NC	/	Advise grounding	/	/	/

Figure 3-2 RPLIDAR S2 Pin Definition and Specification

RPLIDAR S2 uses the one 5V DC power supply for powering the scan motor and the scan core at the same time. No extra power is required.

With build-in and speed-adjustable motor driver, RPLIDAR S2 can control the start, the stop and the rotating speed of the motor via the MOTOCTL signal.

- Reference Design for RPLIDAR development

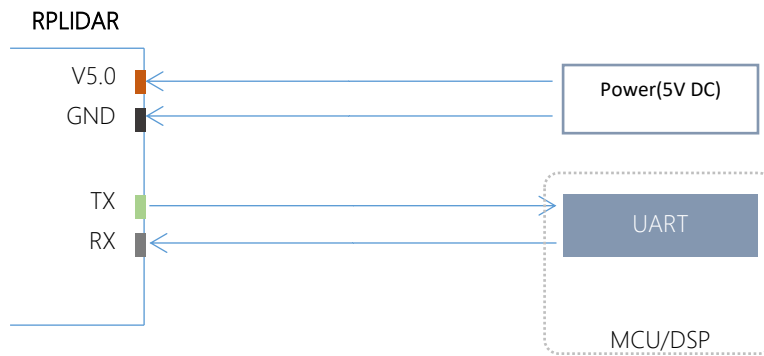

Figure 3-3 RPLIDAR S2 Pins Reference Design

Pin Definition for the USB Adapter

The USB adapter is also using XH2.54-5P specification socket, and it can be connected with RPLIDAR S2 directly. The pin definition is the same as the RPLIDAR S2.

USB-DC power cord instruction

The developer kit provides USB-DC power cord for the user to connect additional power to the USB adapter for additional power supply. For the output voltage and current requirements of the power supply, please refer to the datasheet of the corresponding lidar model.

Configure RPLIDAR S2 Scan Frequency

The RPLIDAR S2's scan frequency can be modified by invoking the related functions in the SDK to configure the motor speed.

Please refer to the RPLIDAR protocol and application note for more information and the SDK for the sample code on RPLIDAR scan frequency.

SDK Usage

SLAMTEC provides RPLIDAR SDK support on both Windows and Linux platform. And users can embed the SDK source code to other operational system or embedded system quickly. Please refer to the SDK document for more information.

Pre-Heating for Best Performance

The scan core will be heating when start working. We recommend pre-heating RPLIDAR (Start the scan mode and the scan motor is rotating) for more than 2 minutes to get the best measurement accuracy.

Ambient Temperature

RPLIDAR's measurement resolution is sensitive to the ambient temperature. Improper use may even damage the sensor. Please avoid using RPLIDAR in extreme high temperature ($>50^{\circ}\text{C}$) and too low temperature ($<-10^{\circ}\text{C}$).

Ambient Light

Compared with RPLIDAR A series, RPLIDAR S2 performs better to resist ambient light interference, which supports it to work properly in outdoor environment.

Date	Version	Description
2019-03-28	1.0	RPLIDAR S2 initial version
2021-12-21	1.1	Delete motoctrl
2024-04-09	1.2	Update RPLIDAR S2 Pin Definition and Specification in Figure 3-2

Image and Table Index

FIGURE 1-1 ITEMS IN THE RPLIDAR DEVELOPMENT KIT.....	3
FIGURE 1-2 THE RPLIDAR S2.....	4
FIGURE 1-3 RPLIDAR ADAPTER.....	4
FIGURE 2-1 CONNECT RPLIDAR S2 AND USB ADAPTER.....	5
FIGURE 2-2 CONNECT THE USB ADAPTER TO PC VIA MICRO-USB CABLE.....	5
FIGURE 2-3 CHOOSE USB ADAPTER DRIVER FOR INSTALLATION.....	6
FIGURE 2-4 START PAGE OF USB ADAPTER DRIVER INSTALLATION.....	6
FIGURE 2-5 RECOGNIZED SERIAL PORT NAME MATCHED WITH THE USB ADAPTER.....	7
FIGURE 2-6 ROBOSTUDIO LOGIN PAGE.....	8
FIGURE 2-7 THE LIDAR PLUGIN IN ROBOSTUDIO.....	9
FIGURE 2-8 THE SUPPORTED COMMANDS OF RPLIDAR IN ROBOSTUDIO.....	9
FIGURE 2-9 THE SCAN OUTLINE BY RPLIDAR IN ROBOSTUDIO.....	10
FIGURE 2-10 THE MOTOR SPEED ADJUSTMENT DIALOGUE OF RPLIDAR IN ROBOSTUDIO.....	11
FIGURE 3-1 RPLIDAR S2 PINS.....	12
FIGURE 3-2 RPLIDAR S2 PIN DEFINITION AND SPECIFICATION.....	12
FIGURE 3-3 RPLIDAR S2 PINS REFERENCE DESIGN.....	13